

櫃體尺寸：W785xD455xH600mm，合下列瓷盆



**SI-A-80-29200** (含瓷盆，不含龍頭)  
(可選擇胡桃木色SI-F-80-29200)



**5080C 中邊盆** W800XD480XH210mm  
**SI-A-80C-29200**



**5080K 中邊盆** W800XD475XH210mm  
**SI-A-80K-29200**



**T-80 薄邊盆** W815XD470XH180mm  
**SI-A-80T-29200**



**5080Q 中邊盆** W815XD485XH210mm  
**SI-A-80Q-29200**



**SI-F-90-33800** (含瓷盆，不含龍頭)  
(可選擇加拿大冷杉SI-A-90-33800)

櫃體尺寸：W885xD455xH600mm，合下列瓷盆



**T-90 薄邊盆** W910XD465XH180mm  
**SI-F-90T-33800**



**5090Q 中邊盆** W930XD485XH210mm  
**SI-F-90Q-33800**

櫃體尺寸：W985xD455xH600mm，合下列瓷盆



**SI-A-100-35200** (含瓷盆，不含龍頭)  
(可選擇胡桃木色SI-F-100-35200)



**5100C 中邊盆** W1000XD480XH210mm  
**SI-A-100C-35200**



**5100K 中邊盆** W1010XD480XH210mm  
**SI-A-100K-35200**



**T-100 薄邊盆** W1000XD465XH180mm  
**SI-A-100T-35200**



**5100Q 中邊盆** W1025XD490XH210mm  
**SI-A-100Q-35200**

## 雙滑門 DOUBLE SLIDING DOOR

DSD-75-26800 雙滑門浴櫃

【合COR-T75瓷盆 尺寸W75xD46.5】

DSD-F-80-26800 胡桃木雙滑門浴櫃

DSD-T-80-26800 柚木雙滑門浴櫃

DSD-F-90-29900 胡桃木雙滑門浴櫃

DSD-T-90-29900 柚木雙滑門浴櫃

DSD-F-100-33600 胡桃木雙滑門浴櫃

DSD-T-100-33600 柚木雙滑門浴櫃

※胡桃木及胡桃木薄片木紋，為天然生成；圖片僅供參考，請依實物為主。



### 板 材

櫃體100%防水實心發泡板18mm：  
非低廉木心板或15mm薄板



### 外 型

胡桃木/柚木實木造型外框噴漆  
雙側貼胡桃木/柚木美耐板  
門片發泡板貼胡桃木/柚木實木皮噴漆  
可拆卸式橫拉門片，方便維修、拆裝

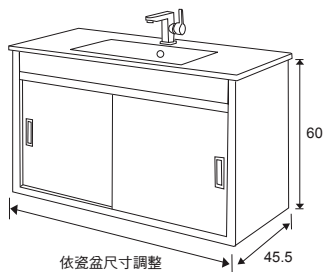

DSD-F-80T-26800



DSD-T-100C-33600



櫃體尺寸：W790xD455xH600mm，合下列瓷盆



**DSD-F-80-26800** (含瓷盆，不含龍頭)  
(可選擇柚木色**DSD-T-80-26800**)



5080C 中邊盆 W800XD480XH210mm  
**DSD-F-80C-26800**



5080K 中邊盆 W800XD475XH210mm  
**DSD-F-80K-26800**



T-80 薄邊盆 W815XD465XH180mm  
**DSD-F-80T-26800**



5080Q 中邊盆 W815XD485XH210mm  
**DSD-F-80Q-26800**



**DSD-F-90-29900** (含瓷盆，不含龍頭)  
(可選擇柚木色**DSD-T-90-29900**)

櫃體尺寸：W885xD455xH600mm，合下列瓷盆



T-90 薄邊盆 W910XD465XH180mm  
**DSD-F-90T-29900**



5090Q 中邊盆 W930XD485XH210mm  
**DSD-F-90Q-29900**



**DSD-T-100-33600** (含瓷盆，不含龍頭)  
(可選擇胡桃木色**DSD-F-100-33600**)

櫃體尺寸：W990xD455xH600mm，合下列瓷盆



5100C 中邊盆 W1000XD480XH210mm  
**DSD-T-100C-33600**



5100K 中邊盆 W1010XD480XH210mm  
**DSD-T-100K-33600**



T-100 薄邊盆 W1000XD465XH180mm  
**DSD-T-100T-33600**



5100Q 中邊盆 W1025XD490XH210mm  
**DSD-T-100Q-33600**



RG-80T-28500



RG-120DZ-50000 120cm檯面雙臉盆

## 大甘木 REDE GUM

RG-80-28500 大甘木浴櫃【合COR-T80瓷盆】

RG-100-33000 大甘木浴櫃【合COR-T100瓷盆】

RG-120DZ-50000 大甘木浴櫃【合COR-120DZ瓷盆(雙盆)】

RG-90-31000 大甘木浴櫃【合COR-T90瓷盆】

RG-120-46000 大甘木浴櫃【合COR-T120瓷盆(單盆)】

※實木皮之木紋，為天然生成；圖片僅供參考，請依實物為主。



### 板 材

櫃體100%防水實心發泡板18mm：  
非低廉木心板或15mm薄板



### 外 型

櫃體雙側貼大甘木實木皮噴漆  
斜把手門片，發泡板面貼大甘木  
實木皮噴漆

櫃體尺寸：W785xD455xH600mm，合下列瓷盆



RG-80-28500 (含瓷盆，不含龍頭)



5080C 中邊盆 W800XD480XH210mm  
RG-80C-28500



5080K 中邊盆 W800XD475XH210mm  
RG-80K-28500



T-80 薄邊盆 W815XD470XH180mm  
RG-80T-28500



5080Q 中邊盆 W815XD485XH210mm  
RG-80Q-28500





**RG-90-31000** (含瓷盆，不含龍頭)

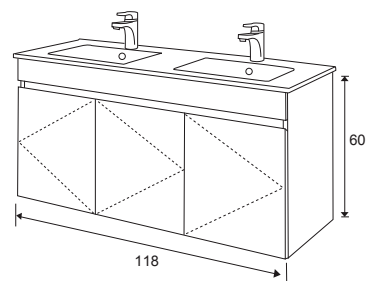
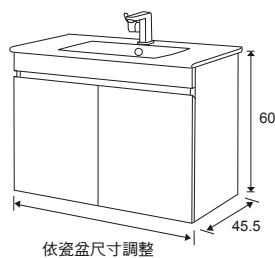

櫃體尺寸：W885xD455xH600mm，合下列瓷盆



T-90 薄邊盆 W910xD465XH180mm

**RG-90T-31000**



5090Q 中邊盆 W930xD485XH210mm

**RG-90Q-31000**



**RG-100-33000** (含瓷盆，不含龍頭)



5100C 中邊盆 W1000xD480XH210mm

**RG-100C-33000**



5100K 中邊盆 W1010xD480XH210mm

**RG-100K-33000**



T-100 薄邊盆 W1000xD465XH180mm

**RG-100T-33000**



5100Q 中邊盆 W1025xD490XH210mm

**RG-100Q-33000**

櫃體尺寸：W1180xD455xH600mm，合下列瓷盆



**RG-120-46000** (含瓷盆，不含龍頭)



T-120 薄邊盆 W1215xD470XH180mm

**RG-120T-46000**



5120Q 中邊盆 W1220xD480XH210mm

**RG-120Q-46000**



5120DZ 薄邊盆 W1210xD465XH210mm

**RG-120DZ-50000**

## 爵士 JS

- JS-F-80-26800 胡桃木爵士浴櫃
- JS-T-80-26800 柚木爵士浴櫃
- JS-F-90-29900 胡桃木爵士浴櫃
- JS-T-90-29900 柚木爵士浴櫃
- JS-F-100-33600 胡桃木爵士浴櫃
- JS-T-100-33600 柚木爵士浴櫃

※胡桃木和柚木實木及薄片木紋，為天然生成；圖片僅供參考，請依實物為主。



### 板 材

櫃體100%防水實心發泡板18mm：  
非低廉木心板或15mm薄板



### 外 型

胡桃木實木/柚木實木藝術造型框  
雙側貼合胡桃木皮/柚木紋美耐板  
斜把手門片，發泡板貼胡桃木/柚木實木皮噴漆

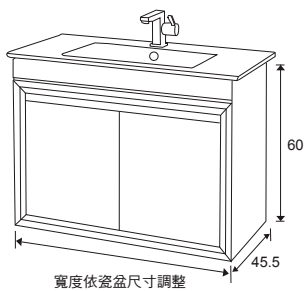

寬度依瓷盆尺寸調整



JS-F-80T-26800



JS-T-80K-26800



櫃體尺寸：W785xD455xH600mm，合下列瓷盆



**JS-T-80-26800** (含瓷盆，不含龍頭)  
(可選擇胡桃木色**JS-F-80-26800**)



5080C 中邊盆 W800XD480XH210mm  
**JS-T-80C-26800**



5080K 中邊盆 W800XD475XH210mm  
**JS-T-80K-26800**



T-80 薄邊盆 W815XD470XH180mm  
**JS-T-80T-26800**



5080Q 中邊盆 W815XD485XH210mm  
**JS-T-80Q-26800**

櫃體尺寸：W885xD455xH600mm，合下列瓷盆



**JS-F-90-29900** (含瓷盆，不含龍頭)  
(可選擇柚木色**JS-T-90-29900**)



T-90 薄邊盆 W910XD465XH180mm  
**JS-F-90T-29900**



T-90L 薄邊盆 W920XD470XH180mm  
**JS-F-T90L-29900**



T-90R 薄邊盆 W915XD470XH180mm  
**JS-F-T90R-29900**



5090Q 中邊盆 W930XD485XH210mm  
**JS-F-90Q-29900**

櫃體尺寸：W985xD455xH600mm，合下列瓷盆



**JS-F-100-33600** (含瓷盆，不含龍頭)  
(可選擇柚木色**JS-T-100-33600**)



5100C 中邊盆 W1000XD480XH210mm  
**JS-F-100C-33600**



5100K 中邊盆 W1010XD480XH210mm  
**JS-F-100K-33600**



T-100 薄邊盆 W1000XD465XH180mm  
**JS-F-100T-33600**



5100Q 中邊盆 W1025XD490XH210mm  
**JS-F-100Q-33600**

## 柚木 TEAK

### TKL-80-37600 柚木浴櫃

【合COR-818B瓷盆 尺寸W46xD46xH15cm】

※櫃身及門片以實木柚木拼板製作，獨特品味及造型。  
※非規格品可訂製。



#### 板 材

左右側板18mm實木柚木拼板  
底板18mm實心發泡板



#### 檯 面

檯面厚度18mm天然柚木拼板  
表面特殊防潮噴漆處理，  
與側板45°斜接成型



#### 外 型

外前檔天然柚木拼板  
天然柚木拼板，無把手門片

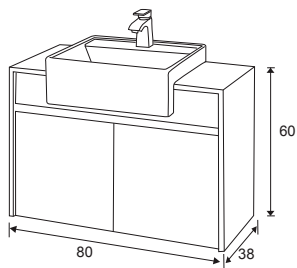

TKL-80-37600







TKW-80-29200

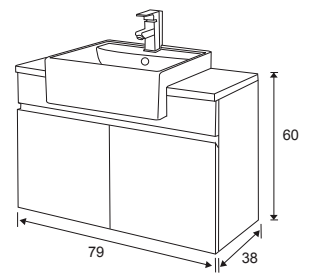

## 柚木 TEAK

TKW-80-29200 柚木浴櫃【合COR-818B瓷盆 尺寸W46xD46xH15cm 或 COR-8050A瓷盆 尺寸W51xD50xH16cm】

※柚木實木木紋，為天然生成；圖片僅供參考，請依實物為主。  
 ※非規格品可訂製。



**板 材**  
 櫃體100%防水實心發泡板18mm；  
 非低廉木心板或15mm薄板



**外 型**  
 外前檔18mm天然柚木拼板；  
 雙側貼白色壓克力  
 結晶鋼烤斜把手門片



**檯 面**  
 檯面厚度30mm天然柚木拼板  
 表面特殊防潮噴漆處理

## 柚木 (平線紗) TEAK

- TKS-60-24500 柚木浴櫃【合COR-T75瓷盆】  
 TKS-80-29000 柚木浴櫃【合COR-T80瓷盆】  
 TKS-90-32000 柚木浴櫃【合COR-T90瓷盆】  
 TKS-100-35200 柚木浴櫃【合COR-T100瓷盆】

※柚木實木木紋，為天然生成；圖片僅供參考，請依實物為主。



### 外型

外前檔柚木拼板實木；櫃體雙側貼合柚木美耐板  
 柚木實木框，前擋鑲復古鏡，門片鑲強化平線紗玻璃

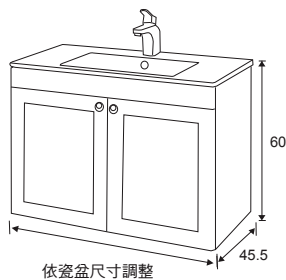

**TKS-60-24500** (含瓷盆，不含龍頭)

櫃體尺寸：W585xD455xH600mm  
 合下列瓷盆



5060C 中邊盆 W610XD475XH210mm

**TKS-60C-24500**



5060K 中邊盆 W610XD480XH210mm

**TKS-60K-24500**



T-60 薄邊盆 W610XD465XH180mm

**TKS-60T-24500**



5060Q 中邊盆 W620XD490XH210mm

**TKS-60Q-24500**







**TKS-80-29000** (含瓷盆, 不含龍頭)



**TKS-90-32000** (含瓷盆, 不含龍頭)



**TKS-100-35200** (含瓷盆, 不含龍頭)

櫃體尺寸：W785xD455xH600mm  
合下列瓷盆

櫃體尺寸：W885xD455xH600mm  
合下列瓷盆

櫃體尺寸：W985xD455xH600mm  
合下列瓷盆



5080C 中邊盆 W800XD480XH210mm  
**TKS-80C-29000**



T-90 薄邊盆 W910XD465XH180mm  
**TKS-90T-32000**



5100C 中邊盆 W1000XD480XH210mm  
**TKS-100C-35200**



5080K 中邊盆 W800XD475XH210mm  
**TKS-80K-29000**



5090Q 中邊盆 W930XD485XH210mm  
**TKS-90Q-32000**



5100K 中邊盆 W1010XD480XH210mm  
**TKS-100K-35200**



T-80 薄邊盆 W815XD470XH180mm  
**TKS-80T-29000**



T-100 薄邊盆 W1000XD465XH180mm  
**TKS-100T-35200**



5080Q 中邊盆 W815XD485XH210mm  
**TKS-80Q-29000**



5100Q 中邊盆 W1025XD490XH210mm  
**TKS-100Q-35200**



DUB-80T-35400



**板 材**  
櫃體100%防水實心發泡板18mm：  
非低廉木心板或15mm薄板



**外 觀**  
門片及櫃體45°斜邊造型/晶彩烤漆



**抽 屜**  
上下雙抽/三節緩關滑軌  
可更換為鉛抽緩關(另加價)

## 雙抽櫃 DOUBLE DRAWER

DUB-75-34700

【合COR-T75瓷盆 尺寸W75xD46】

DUB-80-35400

DUB-90-41000

DUB-100-43100

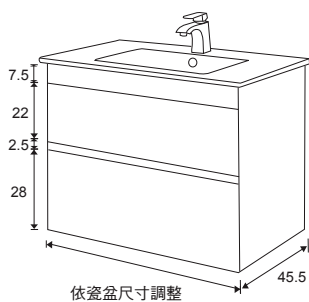

依瓷盆尺寸調整

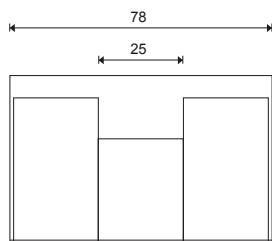

### 【上抽抽屜尺寸及形式】

三角凡爾位置需於上抽預留尺寸內  
落水口下緣高度不得少於43cm  
避免無法順利安裝

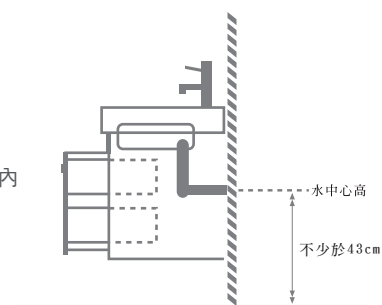





**DUB-80-35400** (含瓷盆，不含龍頭)



**DUB-90-41000** (含瓷盆，不含龍頭)



**DUB-100-43100** (含瓷盆，不含龍頭)

櫃體尺寸：W785xD455xH600mm  
合下列瓷盆

櫃體尺寸：W885xD455xH600mm  
合下列瓷盆

櫃體尺寸：W990xD455xH600mm  
合下列瓷盆



5080C 中邊盆 W800XD480XH210mm  
**DUB-80C-35400**



T-90 薄邊盆 W910XD465XH180mm  
**DUB-90T-41000**



5100C 中邊盆 W1000XD480XH210mm  
**DUB-100C-43100**



5080K 中邊盆 W800XD475XH210mm  
**DUB-80K-35400**



5090Q 中邊盆 W930XD485XH210mm  
**DUB-90Q-41000**



5100K 中邊盆 W1010XD480XH210mm  
**DUB-100K-43100**



T-80 薄邊盆 W815XD470XH180mm  
**DUB-80T-35400**



T-100 薄邊盆 W1000XD465XH180mm  
**DUB-100T-43100**



5080Q 中邊盆 W815XD485XH210mm  
**DUB-80Q-35400**



5100Q 中邊盆 W1025XD490XH210mm  
**DUB-100Q-43100**



LI-41-24200

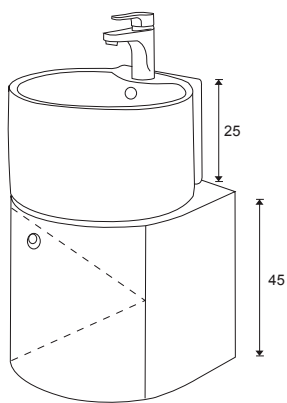

## 小可愛 LIKABLE LOVABLE

LI-41-24200 小可愛浴櫃【合COR-6083瓷盆 尺寸W41xD43xH25】



### 板 材

櫃體100%防水實心發泡板18mm：  
非低廉木心板或15mm薄板



### 門片開向

規格品右外開門方向/鉸鍊在右



### 外 型

復古造型瓷盆、櫃體嬌小；  
小空間仍可安裝使用  
圓弧型造型白色烤漆門片



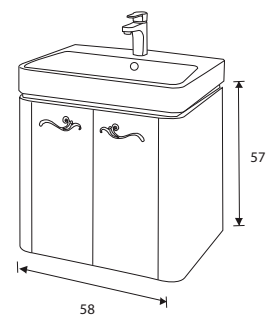

## 圓舞曲 ROUNDLY

RO-66-27300 圓舞曲浴櫃【合COR-6066瓷盆 尺寸W61xD46cm】



**板 材**  
櫃體100%防水實心發泡板18mm；  
非低廉木心板或15mm薄板



**外 型**  
櫃體雙側特殊流線造型全櫃烤漆  
造型把手設計

## 發八線 EIGHT LINE

EL-46F-20000 發八線浴櫃  
【合COR-46F瓷盆 尺寸W46xD46cm】

EL-58F-23100 發八線浴櫃  
【合COR-58F瓷盆 尺寸W58xD43cm】



### 板 材

櫃體100%防水實心發泡板18mm；  
非低廉木心板或15mm薄板



### 門片開向

46F門片標準品為右外開  
58F門片為雙扇門



### 外 型

雙側貼合白色結晶板  
實心發泡板雕刻八線造型晶采烤門片  
上方黑色頸飾

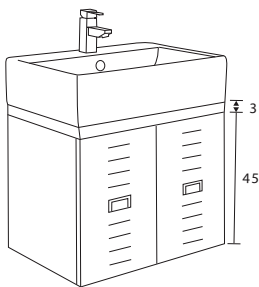
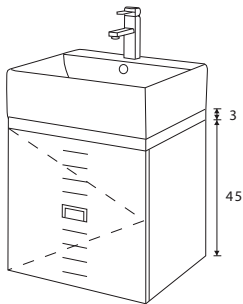

EL-46F-20000



EL-58F-23100



# 芙蓉 HIBISCUS

HI-50-17600 芙蓉浴櫃【合C-003碗公盆 尺寸WØ45xH15，枱面寬50cm】

HI-60-18600 芙蓉浴櫃【合C-003碗公盆 尺寸WØ45xH15，枱面寬60cm】

※枱面加寬可訂做。

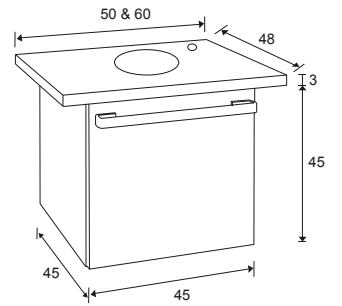

## 板 材

櫃體100%防水實心發泡板18mm：  
非低廉木心板或15mm薄板



## 外 型

枱板：3cm厚結晶鋼烤  
門片：白色結晶板鋁封加毛巾桿把手  
碗公瓷盆：Ø45xH20cm



HI-50R-17600 (向右開)  
HI-50L-17600 (向左開)



HI-60R-18600 (向右開)  
HI-60L-18600 (向左開)





## 百合A LILY-A

- LI-A-60-23600 百合浴櫃【含瓷盆】
- LI-A-80-27500 百合浴櫃【含瓷盆】
- LI-A-90-32000 百合浴櫃【含瓷盆】
- LI-A-100-34500 百合浴櫃【含瓷盆】



### 板 材

櫃體100%防水實心發泡板18mm；  
非低廉木心板或15mm薄板



### 外 型

櫃體雙側貼合白色結晶板，發泡板L型無把手  
晶采烤門片



LI-A-60-23600 (含瓷盆，不含龍頭)

櫃體尺寸：W585xD455xH600mm  
合下列瓷盆



5060C 中邊盆 W610XD475XH210mm  
LI-A-60C-23600



5060K 中邊盆 W610XD480XH210mm  
LI-A-60K-23600



T-60 薄邊盆 W610XD465XH180mm  
LI-A-60T-23600



5060Q 中邊盆 W620XD490XH210mm  
LI-A-60Q-23600



LI-A-60T-23600





**LI-A-80-27500** (含瓷盆，不含龍頭)



**LI-A-90-32000** (含瓷盆，不含龍頭)



**LI-A-100-34500** (含瓷盆，不含龍頭)

櫃體尺寸：W785xD455xH600mm  
合下列瓷盆

櫃體尺寸：W885xD455xH600mm  
合下列瓷盆

櫃體尺寸：W990xD455xH600mm  
合下列瓷盆



5080C 中邊盆 W800xD480XH210mm  
**LI-A-80C-27500**



T-90 薄邊盆 W910xD465XH180mm  
**LI-A-90T-32000**



5100C 中邊盆 W1000xD480XH210mm  
**LI-A-100C-34500**



5080K 中邊盆 W800xD475XH210mm  
**LI-A-80K-27500**



5090Q 中邊盆 W930xD485XH210mm  
**LI-A-90Q-32000**



5100K 中邊盆 W1010xD480XH210mm  
**LI-A-100K-34500**



T-80 薄邊盆 W815xD470XH180mm  
**LI-A-80T-27500**



T-100 薄邊盆 W1000xD465XH180mm  
**LI-A-100T-34500**



5080Q 中邊盆 W815xD485XH210mm  
**LI-A-80Q-27500**



5100Q 中邊盆 W1025xD490XH210mm  
**LI-A-100Q-34500**

## 百合B LILY-B

- LI-B-60-24000 百合浴櫃【含瓷盆】
- LI-B-80-28500 百合浴櫃【含瓷盆】
- LI-B-90-33000 百合浴櫃【含瓷盆】
- LI-B-100-35500 百合浴櫃【含瓷盆】



### 板 材

櫃體100%防水實心發泡板18mm；  
非低廉木心板或15mm薄板



### 外 型

櫃體雙側貼合白色結晶板，  
發泡板立體雕刻造型晶采烤門片



LI-B-60-24000 (含瓷盆·不含龍頭)

櫃體尺寸：W585xD455xH600mm  
合下列瓷盆



5060C 中邊盆 W610xD480XH210mm  
LI-B-60C-24000



5060K 中邊盆 W610xD480XH210mm  
LI-B-60K-24000



T-60 薄邊盆 W610xD465XH180mm  
LI-B-60T-24000



5060Q 中邊盆 W620xD490XH210mm  
LI-B-60Q-24000



LI-B-60T-24000





**LI-B-80-28500** (含瓷盆, 不含龍頭)



**LI-B-90T-33000** (含瓷盆, 不含龍頭)



**LI-B-100-35500** (含瓷盆, 不含龍頭)

櫃體尺寸：W785xD455xH600mm  
合下列瓷盆



5080C 中邊盆 W800XD480XH210mm

**LI-B-80C-28500**



**LI-B-90Q-33000** (含瓷盆, 不含龍頭)

櫃體尺寸：W985xD455xH600mm  
合下列瓷盆



5100C 中邊盆 W1000XD480XH210mm

**LI-B-100C-35500**



5080K 中邊盆 W800XD475XH210mm

**LI-B-80K-28500**



**LI-B-90TL-36500** (含瓷盆, 不含龍頭)



5100K 中邊盆 W1010XD480XH210mm

**LI-B-100K-35500**



T-80 薄邊盆 W815XD470XH180mm

**LI-B-80T-28500**



**LI-B-90TR-36500** (含瓷盆, 不含龍頭)



T-100 薄邊盆 W1000XD465XH180mm

**LI-B-100T-35500**



5080Q 中邊盆 W815XD485XH210mm

**LI-B-80Q-28500**



5100Q 中邊盆 W1025XD490XH210mm

**LI-B-100Q-35500**

## 百合C LILY-C

- LI-C-60-21500 百合浴櫃【含瓷盆】
- LI-C-80-25500 百合浴櫃【含瓷盆】
- LI-C-90-29000 百合浴櫃【含瓷盆】
- LI-C-100-31500 百合浴櫃【含瓷盆】



### 板 材

櫃體100%防水實心發泡板18mm；  
非低廉木心板或15mm薄板



### 外 型

櫃體雙側貼合白色結晶板，發泡板面貼白色結晶板  
鋁封邊嵌鋁把手



LI-C-60-21500 (含瓷盆，不含龍頭)

櫃體尺寸：W585xD455xH600mm  
合下列瓷盆



5060C 中邊盆 W610XD475XH210mm  
LI-C-60C-21500



5060K 中邊盆 W610XD480XH210mm  
LI-C-60K-21500



T-60 薄邊盆 W610XD465XH180mm  
LI-C-60T-21500



5060Q 中邊盆 W620XD490XH210mm  
LI-C-60Q-21500



LI-C-100Q-31500





**LI-C-80-25500** (含瓷盆，不含龍頭)



**LI-C-90-29000** (含瓷盆，不含龍頭)



**LI-C-100-31500** (含瓷盆，不含龍頭)

櫃體尺寸：W785xD455xH600mm  
合下列瓷盆

櫃體尺寸：W885xD455xH600mm  
合下列瓷盆

櫃體尺寸：W990xD455xH600mm  
合下列瓷盆



**5080C 中邊盆** W800xD480XH210mm  
**LI-C-80C-25500**



**T-90 薄邊盆** W910xD465XH180mm  
**LI-C-90T-29000**



**5100C 中邊盆** W1000xD480XH210mm  
**LI-C-100C-31500**



**5080K 中邊盆** W800xD475XH210mm  
**LI-C-80K-25500**



**5090Q 中邊盆** W930xD485XH210mm  
**LI-C-90Q-29000**



**5100K 中邊盆** W1010xD480XH210mm  
**LI-C-100K-31500**



**T-80 薄邊盆** W815xD470XH180mm  
**LI-C-80T-25500**



**T-100 薄邊盆** W1000xD465XH180mm  
**LI-C-100T-31500**



**5080Q 中邊盆** W815xD485XH210mm  
**LI-C-80Q-25500**



**5100Q 中邊盆** W1025xD490XH210mm  
**LI-C-100Q-31500**

## 瑞特浴櫃型式選擇

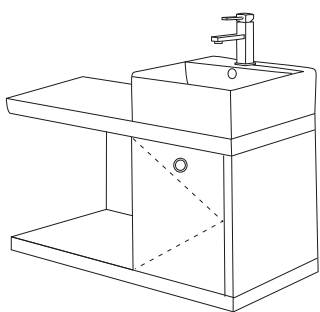

RE-A-85R-22600  
RE-G-85R-22000

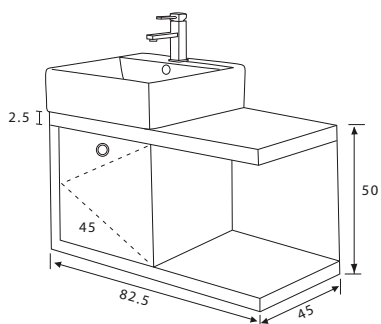

RE-A-85L-22600  
RE-G-85L-22600



RE-B-85L-22000



RE-G-85R-22000

## 瑞特 RETRO

RE-A-85L-22000  
加拿大冷杉瑞特浴櫃  
【不含檯面盆】

RE-A-85R-22000  
加拿大冷杉瑞特浴櫃  
【不含檯面盆】

RE-G-85L-22000  
古巴硬木瑞特浴櫃  
【不含檯面盆】

RE-G-85R-22000  
古巴硬木瑞特浴櫃  
【不含檯面盆】



### 檯面

檯上盆可依現場空間偏左或偏右  
兩種檯上盆：方型COR-46F、  
COR-7021任您選



### 外型

櫃體面貼加拿大冷杉美耐板及  
古巴硬木美耐板  
門片為白色結晶鋼烤

## 瓷盆可選擇



COR 46F-6500 尺寸W46xD46xH15cm



7021-6700 尺寸W51xD42xH15cm





N-DJ-60-19900



N-DJ-80-24100



N-DJ-100-29400



N-DJ-100R-33600



N-DJ-100L-33600

## 新迪爵 NEW D.J

N-DJ-60-19900 迪爵浴櫃【合COR-60Z瓷盆 尺寸W61xD51cm】

N-DJ-80-24100 迪爵浴櫃【合COR-80Z瓷盆 尺寸W81xD50cm】

N-DJ-100-29400 迪爵浴櫃【合COR-100Z瓷盆 尺寸W102.5xD50cm】

N-DJ-100R-33600 迪爵浴櫃【合COR-100Z瓷盆 尺寸W102.5xD50cm】

N-DJ-100L-33600 迪爵浴櫃【合COR-100Z瓷盆 尺寸W102.5xD50cm】



**板 材**  
櫃體100%防水實心發泡板、門片



**外 型**  
櫃體雙側貼合白色結晶板  
結晶板鋁封邊門片+鋁把手  
抽軌三節全拉

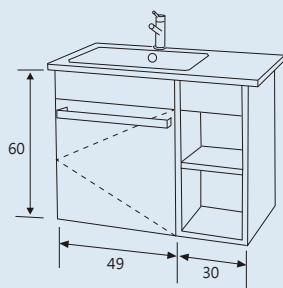

N-DM-80L

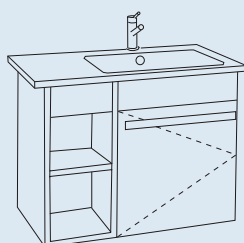

N-DM-80R



● 雙彎毛巾桿/標準配備



NDM-80L-2990

## 新夢幻 NEW DREAM

N-DM-80L-2990 夢幻浴櫃【合COR-T80-L瓷盆 尺寸W80xD46.5cm】

N-DM-80R-2990 夢幻浴櫃【合COR-T80-R瓷盆 尺寸W80xD46.5cm】



板 材  
櫃體+門片100%防水實心發泡板



外 型  
開放櫃為發泡板貼加拿大冷杉美耐板  
櫃體雙側貼合白色結晶板  
門片結晶板鋁封邊加雙彎毛巾桿把手，





DM-80R-32000

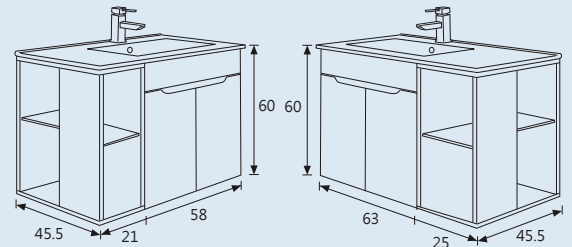

DM-80R

DM-90L



**板 材**

櫃體+門片100%防水實心發泡板



**外 型**

開放櫃為發泡板，貼合柚木色美耐板  
櫃體雙側貼合白色結晶板  
門片為發泡板L型無把手晶采烤



DM-90L-34700

**夢幻** DREAM

DM-80R-32000 夢幻浴櫃 盆在右【合COR-T80R瓷盆 尺寸W81xD46.5cm】

DM-80L-32000 夢幻浴櫃 盆在左【合COR-T80L瓷盆 尺寸W81xD46.5cm】

DM-90R-34700 夢幻浴櫃 盆在右【合COR-T90R瓷盆 尺寸W92xD46.5cm】

DM-90L-34700 夢幻浴櫃 盆在左【合COR-T90L瓷盆 尺寸W92xD46.5cm】



## 達伯 抽中抽 DOUBLE



**板 材**  
櫃體+門片100%防水實心發泡板



**外 型**  
櫃體雙側貼合白色結晶板  
雙色門片選擇：  
純黑/雪白結晶板亮鉻色鋁封邊  
門片附新潮造型毛巾桿，  
可彈性選擇加裝側毛巾桿



**抽 屜**  
上下雙抽之收納功能設計  
上抽為三節全拉軌  
下抽為緩關式重型抽軌





- 獨家設計：  
抽屜內另有抽屜，淺抽深25cm，收納更便利；  
大抽(凹型抽)搭配隱藏緩關式滑軌，  
輕鬆開閉。

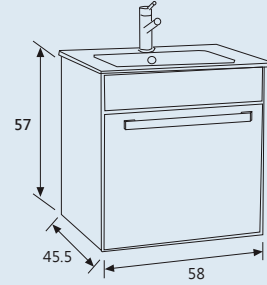
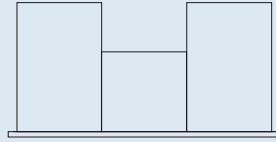

櫃體尺寸：W585xD455xH570mm，合下列瓷盆



**DB-03B-60-25700** (含瓷盆，不含龍頭)



5060C 中邊盆 W610xD475xH210mm  
**DB-03B-60C-25700**



5060K 中邊盆 W610xD480xH210mm  
**DB-03B-60K-25700**



T-60 薄邊盆 W610xD465xH180mm  
**DB-03B-60T-25700**



5060Q 中邊盆 W620xD490xH210mm  
**DB-03B-60Q-25700**

櫃體尺寸：W585xD455xH570mm，合下列瓷盆



**DB-04B-60-25700** (含瓷盆，不含龍頭)



5060C 中邊盆 W610xD475xH210mm  
**DB-04B-60C-25700**



5060K 中邊盆 W610xD480xH210mm  
**DB-04B-60K-25700**



T-60 薄邊盆 W610xD465xH180mm  
**DB-04B-60T-25700**



5060Q 中邊盆 W620xD490xH210mm  
**DB-04B-60Q-25700**

## 百憂解 AGREEABLE

### AG-01B-L90F-33100 百憂解浴櫃

【合COR-46F瓷盆 尺寸W46xH15cm】



**板 材**  
櫃體+門片100%防水實心發泡板



**外 型**  
櫃體雙側貼合白色結晶板  
三種門片型式選擇  
可彈性選擇加裝側毛巾桿



**檯 面**  
3cm鋁封邊+面貼黑色壓克力

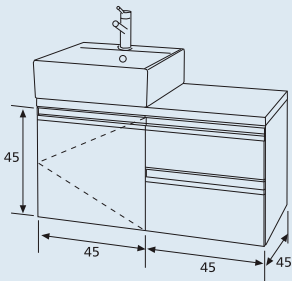

AG-01B-L90F

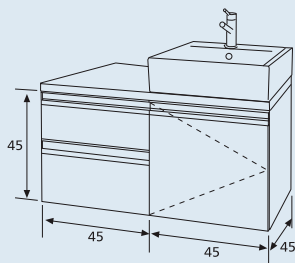

AG-01B-R90F



AG-01B-L90F-33100

## 百憂解 AGREEABLE

AG-01B-46F-18900 百憂解浴櫃【合COR-46F瓷盆 尺寸W46xH15cm/嵌鋁把手+白色結晶板鋁封邊】

AG-03B-46F-19900 百憂解浴櫃【合COR-46F瓷盆 尺寸W46xH15cm/白色結晶板鋁封邊+雙彎毛巾桿把手】

AG-04B-46F-19900 百憂解浴櫃【合COR-46F瓷盆 尺寸W46xH15cm/黑色結晶板鋁封邊+雙彎毛巾桿把手】

※標準門片為右外開：如需訂購左外開，請特別註記。

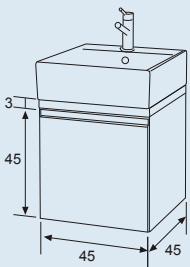

AG-01B-46F-18900



AG-03B-46F-19900



AG-04B-46F-19900



AG-01B-51A-19500 百憂解浴櫃

【合COR-7021瓷盆 尺寸W51xD42xH15cm/嵌鋁把手+結晶板鋁封邊】

AG-03B-51A-20500 百憂解浴櫃

【合COR-7021瓷盆 尺寸W51xD42xH15cm/白色結晶板鋁封邊+雙彎毛巾桿把手】

AG-04B-51A-20500 百憂解浴櫃

【合COR-7021瓷盆 尺寸W51xD42xH15cm/黑色結晶板鋁封邊 雙彎毛巾桿把手】

AG-01B-58F-20500 百憂解浴櫃

【合COR-58F瓷盆 尺寸W58xD43xH15cm/嵌鋁把手+白色結晶板鋁封邊】

AG-03B-58F-21500 百憂解浴櫃

【合COR-58F瓷盆 尺寸W58xD43xH15cm/白色結晶板鋁封邊+雙彎毛巾桿把手】

AG-04B-58F-21500 百憂解浴櫃

【合COR-58F瓷盆 尺寸W58xD43xH15cm/黑色結晶板鋁封邊+雙彎毛巾桿把手】

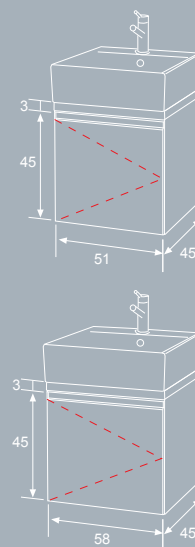

※標準門片為右外開：如需訂購左外開，請特別註記。



板 材

櫃體+門片100%防水實心發泡板



外 型

櫃體雙側貼合白色結晶板  
三種門片型式選擇  
可彈性選擇加裝側毛巾桿



AG-01B-51A-19500



AG-03B-51A-20500



AG-04B-51A-20500



AG-01B-58F-20500



AG-03B-58F-21500



AG-04B-58F-21500

SN-60-23000 香耐爾浴櫃【含瓷盆】

SN-80-27000 香耐爾浴櫃【含瓷盆】

SN-90-30500/34000 香耐爾浴櫃【含瓷盆】

SN-100-33000 香耐爾浴櫃【含瓷盆】



板 材

櫃體+門片100%防水實心發泡板



外 型

櫃體雙側貼合白色結晶板

雪白結晶板+純黑結晶板鋁封邊

可選配新潮造型毛巾桿



SN-90Q-30500 (含瓷盆, 不含龍頭)



SN-90T-30500 (含瓷盆, 不含龍頭)



SN-90TL-34000 (含瓷盆, 不含龍頭)



SN-90TR-34000 (含瓷盆, 不含龍頭)



SN-90TL-34000





**SN-60-23000** (含瓷盆，不含龍頭)



**SN-80-27000** (含瓷盆，不含龍頭)



**SN-100-33000** (含瓷盆，不含龍頭)

櫃體尺寸：W585xD455xH600mm  
合下列瓷盆

櫃體尺寸：W785xD455xH600mm  
合下列瓷盆

櫃體尺寸：W985xD455xH600mm  
合下列瓷盆



5060C 中邊盆 W610XD475XH210mm  
**SN-60C-23000**



5080C 中邊盆 W800XD480XH210mm  
**SN-80C-27000**



5100C 中邊盆 W1000XD480XH210mm  
**SN-100C-33000**



5060K 中邊盆 W610XD480XH210mm  
**SN-60K-23000**



5080K 中邊盆 W800XD475XH210mm  
**SN-80K-27000**



5100K 中邊盆 W1010XD480XH210mm  
**SN-100K-33000**



T-60 薄邊盆 W610XD465XH180mm  
**SN-60T-23000**



T-80 薄邊盆 W815XD470XH180mm  
**SN-80T-27000**



T-100 薄邊盆 W1000XD465XH180mm  
**SN-100T-33000**



5060Q 中邊盆 W620XD490XH210mm  
**SN-60Q-23000**



5080Q 中邊盆 W815XD485XH210mm  
**SN-80Q-27000**



5100Q 中邊盆 W1025XD490XH210mm  
**SN-100Q-33000**

# 禎好洗 GEN WASH

- GN-60A-33100 禎好洗洗衣槽浴櫃【含20cm腳柱x2】
- GN-75A-36200 禎好洗洗衣槽浴櫃【含20cm腳柱x2】
- GN-80B-36700 禎好洗洗衣槽浴櫃【含20cm腳柱x2】
- GN-90A-39900 禎好洗洗衣槽浴櫃【含20cm腳柱x2】
- GN-90B-39900 禎好洗洗衣槽浴櫃【含20cm腳柱x2】
- GN-120-54600 禎好洗洗衣槽浴櫃【含20cm腳柱x2】



## 檯面

實心(透心)人造石洗衣槽檯面  
 枱面100%台灣製造生產(附提籠及排水管)  
 (可自行檯面穿孔接裝龍頭)



## 外型

櫃體實心發泡板雙面貼白色結晶板  
 門片發泡板面貼白色結晶板  
 亮面細鋁封邊 上嵌亮鎳色鋁把手  
 最能適合室外陽台環境  
 降低門片變形機率



◎工作平台，活動式洗衣板，省水設計。

單槽-120洗衣槽(左右水槽二式) W1200XD570XH220  
 洗衣櫃W1180XD560XH600

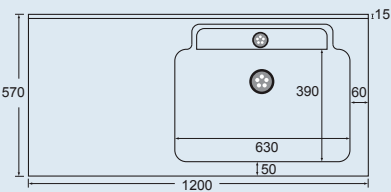

## 單槽-60A 洗衣槽

W605XD540XH220  
 洗衣櫃W590XD540XH600

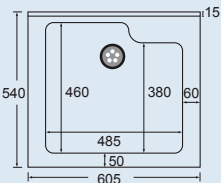

◎採單槽設計，活動式洗衣板。



GN-120R-54600(含20cm腳柱x2)



單槽-75A 洗衣槽 W750XD580XH220  
 洗衣櫃W740XD570XH600

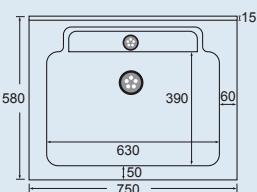

◎採單槽設計，活動式洗衣板。



單槽-90A 洗衣槽 W900XD570XH220  
 洗衣櫃W880XD570XH600

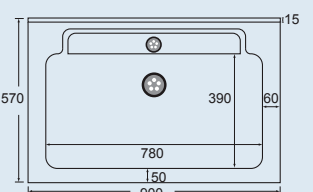

◎採單槽設計，活動式洗衣板。



雙槽-80A 洗衣槽 W800XD580XH220  
 雙槽-80B 洗衣槽 W800XD580XH220  
 洗衣櫃W79XD57XH60

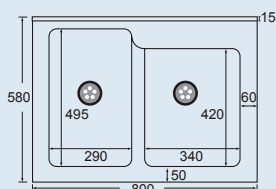

◎採大小高低槽設計，活動式洗衣板，清水污水分離，省水設計。



雙槽-90B 型洗衣槽 W900XD580XH220  
 洗衣櫃W880XD570XH600

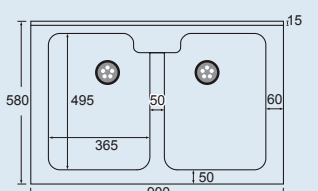

◎採雙槽設計，活動式洗衣板，清水污水分離，省水設計。









EN-60-22600



EN-80R-25700

## 應好洗 ENWASH

EN-60-22600 應好洗浴櫃【合COR-9060E瓷盆 尺寸為W60xD55cm/含F12腳柱12cm x4支】

EN-80R-25700 應好洗浴櫃【合COR-9080E瓷盆(水槽於右邊) 尺寸為W80xD51cm/含F12腳柱12cm x4支】



### 板 材

櫃體+門片100%防水實心發泡板



### 外 型

瓷器檯面大水槽附洗衣板，可置於室外陽台  
門片白色結晶板+鋁封邊，不怕陽光照射而褪色及變形  
櫃體雙側貼合白色結晶板  
附4支腳、歐規翻轉式落水頭及PVC排水管



歐規翻轉式落水頭

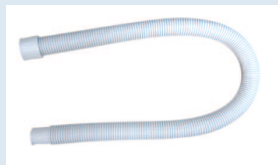

PVC排水管

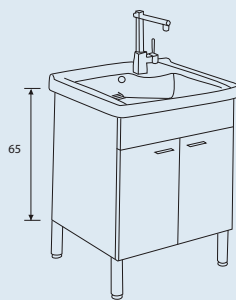

EN-60

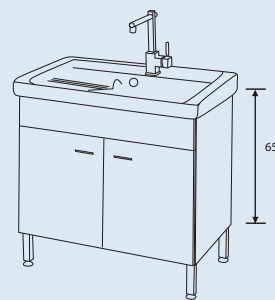

EN-80R





## 司密特 SMART

SM-80-24200 不含檯面盆 司密特浴櫃

## 米蘭 GAN-LAN

GL-80-28900 不含檯面盆 米蘭浴櫃



**檯面/三種檯面盆可供選擇：**  
檯面上搭10mm茶色強化玻璃及可調高度之玻璃調整固定座



**外型**  
極簡造型，整組浴櫃以桃花心木及南洋檜木製成特殊規格可訂作

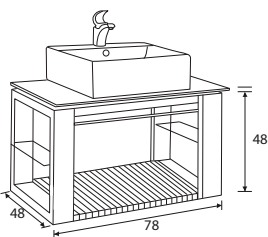

**檯面/三種檯面盆可供選擇：**  
檯面上搭10mm茶色強化玻璃，及可調高度之玻璃調整固定座



**外型**  
木條格柵排列，以90°對線組成浴櫃檯面及櫃身，搭配開放式格柵層板，散發濃厚南洋休閒之風味  
精選南洋桃花心木製造  
特殊規格可訂做

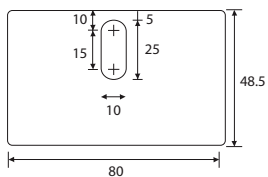
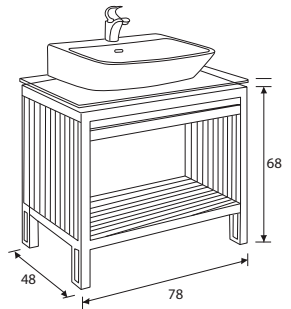

【檯上盆，可選擇】



7021-7030 尺寸51x42x15cm



5039-7030 尺寸58.5x48cm



COR-58F-7300 尺寸58x43cm

## 恩比特 AMBIT

AM-60-23100 恩比特浴櫃【合瓷盆】

AM-80-26500 恩比特浴櫃【合瓷盆】

AM-100-30500 恩比特浴櫃【合瓷盆】



### 板 材

全實木製造，以南洋檜木  
及桃花心木製成



### 瓷 盆

檯面一體瓷盆有60、80或100cm  
三種尺寸、四種形式可供選擇



### 外 型

左右主體，加裝層板玻璃  
更實用

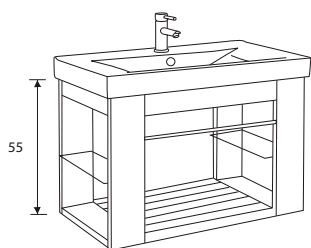

AM-80Q-26500





櫃體尺寸：W585xD455xH550mm，合下列瓷盆



**AM-60-23100** (含瓷盆，不含龍頭)



5060C 中邊盆 W610XD475XH210mm  
**AM-60C-23100**



5060K 中邊盆 W610XD480XH210mm  
**AM-60K-23100**



T-60 薄邊盆 W610XD465XH180mm  
**AM-60T-23100**



5060Q 中邊盆 W620XD490XH210mm  
**AM-60Q-23100**

櫃體尺寸：W785xD455xH550mm，合下列瓷盆



**AM-80-26500** (含瓷盆，不含龍頭)



5080C 中邊盆 W800XD480XH210mm  
**AM-80C-26500**



5080K 中邊盆 W800XD475XH210mm  
**AM-80K-26500**



T-80 薄邊盆 W815XD470XH180mm  
**AM-80T-26500**



5080Q 中邊盆 W815XD485XH210mm  
**AM-80Q-26500**

櫃體尺寸：W990xD455xH550mm，合下列瓷盆



**AM-100-30500** (含瓷盆，不含龍頭)



5100C 中邊盆 W1000XD480XH210mm  
**AM-100C-30500**



5100K 中邊盆 W110XD480XH210mm  
**AM-100K-30500**



T-100 薄邊盆 W1000XD465XH180mm  
**AM-100T-30500**



5100Q 中邊盆 W1025XD490XH210mm  
**AM-100Q-30500**

# 典雅 CLASSICS

- CL-T75-37800/36800(不含腳柱) 典雅浴櫃
- CL-90R-50400/49400(不含腳柱) 典雅浴櫃
- CL-90L-50400/49400(不含腳柱) 典雅浴櫃
- CL-T90-45700/44600(不含腳柱) 典雅浴櫃
- CL-T100-48300/47300(不含腳柱) 典雅浴櫃



**板 材**  
櫃體100%防水實心發泡板：  
雙側貼美耐板



**外 型**  
活動式腳柱，可取消另做  
懸吊式安裝  
桃花心實木門片



**瓷 盆**  
配合瓷盆方向，可選擇  
三抽抽屜裝置於左或右邊  
瓷盆計有偏左、偏右、  
置中三種選擇

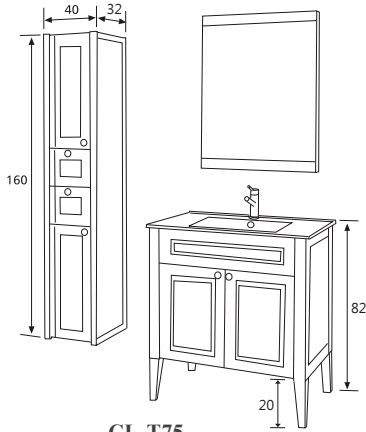

CL-T75



CL-T75-37800

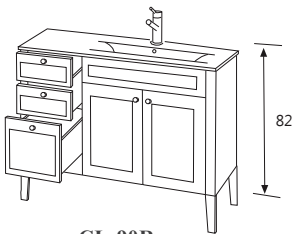

CL-90R

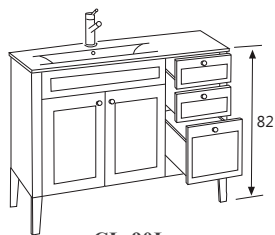

CL-90L

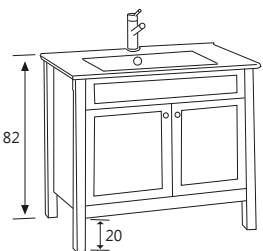

CL-T90



CL-90L-50400



CL-T90-45700





CL-T120-65100

## 典雅 CLASSICS

CL-T120-65100/63500(不含腳柱) 典雅浴櫃  
【合COR-T120瓷盆 尺寸W120xD46.5cm】



### 外型

活動式腳柱，可取消另做懸吊式安裝  
特採桃花心實木門片



### 檯面

超豪華大檯面，更顯尊貴大器、  
無可比擬



### 抽屜

上雙抽屜+雙側門片內附活動層板

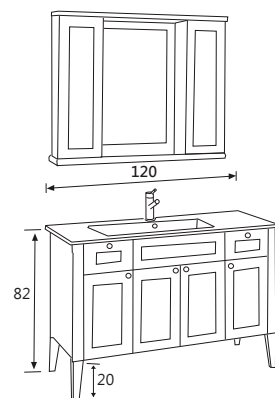

CL-F120-70900

## 典雅 CLASSICS

CL-F120-70900/69300(不含腳柱) 典雅浴櫃  
【合COR-120F瓷盆 尺寸W120xD46.5cm】



### 外型

活動式腳柱，可取消另做懸吊式安裝  
特採桃花心實木門片



### 檯面

超豪華大檯面，更顯尊貴大器、  
無可比擬

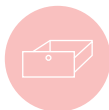

### 抽屜

右雙抽屜+左側門片內附活動層板

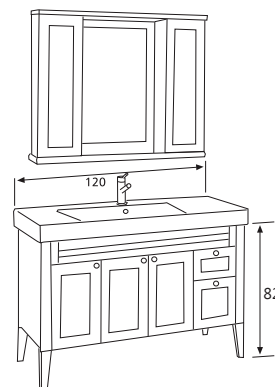



# 新豪仕彼 NEW HOSPI

NH-08B-T60-24200/23500(不含腳柱) 新豪仕彼浴櫃

【含COR-T60瓷盆/含腳柱X2】

NH-08B-T75-29400/28700(不含腳柱) 新豪仕彼浴櫃

【含COR-T75瓷盆/含腳柱X2】

NH-08B-T90L-39400/38700(不含腳柱) 新豪仕彼浴櫃

【含COR-T90L瓷盆/含腳柱X2】

NH-08B-T90R-39400/38700(不含腳柱) 新豪仕彼浴櫃

【含COR-T90R瓷盆/含腳柱X2】

NH-08B-T90-36800/36100(不含腳柱) 新豪仕彼浴櫃

【含COR-T90C瓷盆/含腳柱X2】

NH-08B-T100-38300/37700(不含腳柱) 新豪仕彼浴櫃

【含COR-T100C瓷盆/含腳柱X2】



## 板材

櫃體100%防水實心發泡板：  
面貼實木皮噴漆



## 外型

全系列可搭配吊櫃、矮櫃、高櫃櫃體  
雙側貼合原木色防水美耐板  
活動式腳柱，可取消另做懸吊式安裝  
門片發泡板，面貼頂級胡桃木薄片  
十字紋斜拼花

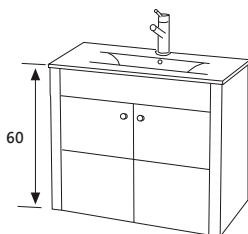

## 瓷盆

配合瓷盆方向，可選擇三抽  
抽屜裝置於左或右邊  
瓷盆計有偏左、偏右、置中  
三種選擇



NH-08B-T60-24200

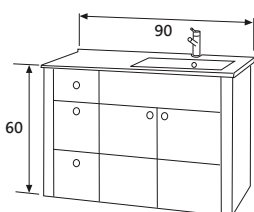

NH-08B-T90R

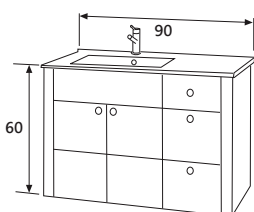

NH-08B-T90L

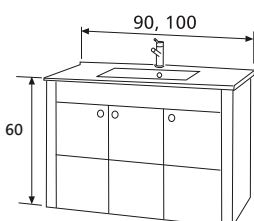

NH-08B-T90(T100)



NH-08B-T90L-38700



NH-08B-T90-36800



# 腳柱 |

浴櫃腳柱【H18cm，可調整高】長度可訂作



F9

F10

F11

F12

## 腳柱

F9. 鋁亮鍍色 尺寸口3x3cm

F11. 鋁鋼拉絲色  $\varnothing$ 35mm

F10. 鋁霧銀色 尺寸口3x3cm

F12. 鋁霧銀色  $\varnothing$ 40mm

Y1L-950單彎毛巾桿

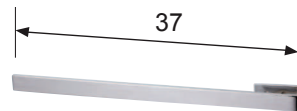

37

Y2L-1200雙彎毛巾桿

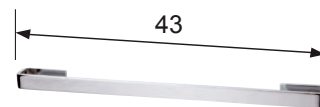

43

# 浴櫃把手 |



上嵌式鋁封邊把手



ZC34-S



ZC76-M



A559



A559



A450



ST-486



A-432



ZS025



**VI-40H-25700**  
 H160xW40xD32cm  
 鋁框銀霞玻高櫃



**PG-40H-25700**  
 H160xW40xD32cm  
 白色烤漆銀霞玻高櫃

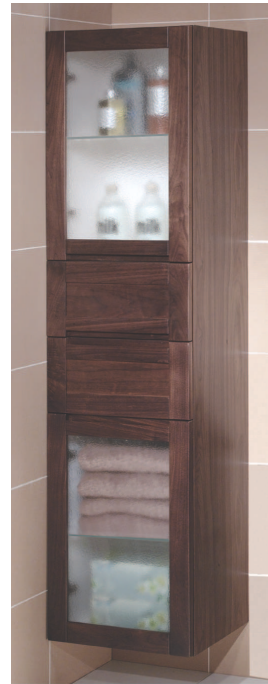

**HO-40H-27300**  
 H160xW40xD32cm  
 胡桃木實木框銀霞玻高櫃



**MI-40H-31000**  
 H160xW40xD32cm  
 典雅實木高櫃



**NO-40L-21000**  
 W40xH110xD32cm  
 胡桃木實木框銀霞玻矮櫃



**SR-40L-19900**  
 W40xH88xD32cm  
 嵌實木把手結晶板，上置人造石檯面



# 吊櫃系列

※櫃身為實心發泡板，雙側貼白色結晶板  
 ※高櫃、吊櫃全系列配置不銹鋼緩關鉸鍊

## 面紙抽吊櫃【W30xH75xD25cm/內附層板玻璃一片/追加另加價】



**SF05 LA-PG-9500**  
 白色烤漆/  
 銀霞玻璃門片



**SF05-NH-9500**  
 胡桃木實木框/  
 銀霞玻璃門片



**SF-05-LG-9100**  
 鋁本色鋁框  
 銀霞玻璃門片

## 轉角吊櫃【W60xH60xD25cm】



**RF-LA-PG-12400(右開放)**  
**RF-LA-PG-12400(左開放)**  
 門片白烤漆/銀霞玻  
 開放櫃內白色結晶板

## 標準吊櫃【W60xH60xD25cm/內附層板玻璃一片】



**SF01 LP-PG-11000**  
 白色烤漆/銀霞玻璃門片



**SF01 N-HOSPI-11000**  
 胡桃木實木框/銀霞玻璃門片



**SF01-LG-10500**  
 鋁本色鋁框銀霞玻璃門片



**SF01-LA-12600**  
 W80xH60xD25cm  
 白色結晶板亮鉻色封邊  
 下嵌亮鉻色鋁把手

## 對開放標準吊櫃【W60xH80xD25cm/內附層板玻璃一片】



**SF11 LF-PG-12100**  
 白色烤漆/銀霞玻璃門片



**SF11 N-HOSPI-12100**  
 胡桃木實木框/銀霞玻璃門片



**SF11-LG-11600**  
 鋁本色鋁框銀霞玻璃門片

# 各式明鏡鏡櫃系列

在乎的，純是一種對生活的尊重與感動



烤漆檯板上嵌黑玻  
5mm明鏡8分斜光邊



**AG-45M-5700**-鋁框明鏡(可橫掛)  
W45xH80cm

**AG-60M-6500**  
W60xH80cm



**DI-60M-10000**-特級鋁框鏡/含置物平檯  
W60xH80cm



**RO-60M-10800**-烤漆檯板明鏡  
W60xH80xD15cm

**RO-80M-13000**  
W80xH80xD15cm



**DJ-45M-7000**-鋁封邊明鏡+烤漆平檯  
W45xH80xD15cm

**DJ-60M-7800** W60xH80xD15cm

**DJ-80M-9000** W60xH80xD15cm



**FA-60-7000**-繪框鏡  
W60xH80cm可橫/立掛



**FB-60-7000**-繪框鏡  
W60xH80cm可橫/立掛



**DR-45-9500**-亮鉻色鋁封邊鏡箱櫃  
W45xH80xD15cm標準品門片右外開

**DR-55-10500**  
W55xH80xD15cm



**TSC-023-3255**-置物端盤(小)  
W23xD12xH5cm



**TSC-038-4253**-置物端盤(大)  
W38xD23xH5cm



**TK-45C-11500**-柚木實木附平台  
明鏡3分斜光邊(柚木色)

W45xH80xD15cm

**TK-60C-12000**-W60xH80xD15cm



**TK-80-10000**-柚木實木拼板

明鏡8分斜光邊(柚木色)

W60xH80cm(可立掛)(特殊尺寸可訂制)



**AS-60-9000**-栓木實木框明鏡(5mm明鏡8分斜光邊)

W60xH80cm(可橫立掛)(特殊尺寸可訂制)



## 各式明鏡鏡櫃系列

※本公司全系列明鏡皆於四周特加防蝕邊處理，可增加明鏡使用壽命。  
 ※鏡片嚴禁使用含酸性或腐蝕性清潔劑擦拭。  
 ※請勿用水噴掃鏡片正面或背面。  
 ※請配合柔軟布巾以清水擦拭。

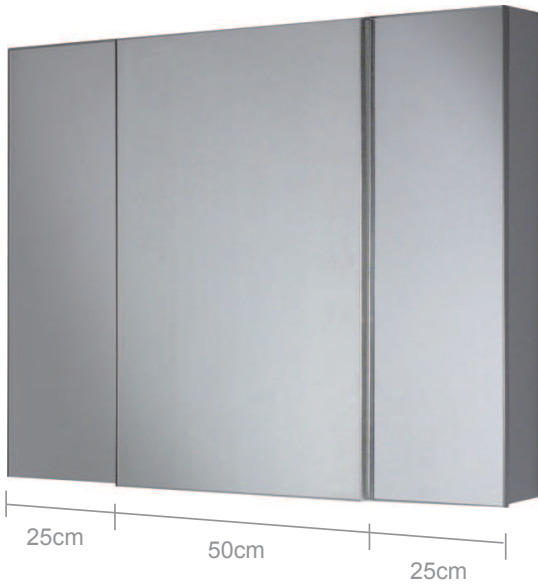

**SR111-100-16000** 三門橫移鏡櫃  
 W100xH80cmxD15cm/D20cm



二門橫移鏡櫃(訂製品)  
 左右二門鏡片可左右互移；取物



中間鏡面可左右橫移



右小鏡面向左移取物



左小鏡面向右移取物

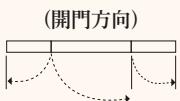

**DR-95-14400**-亮鉻色鋁封邊鏡箱櫃  
 W95xH80xD15cm(25+45+25cm)

**DR-95T-17000**-亮鉻色鋁封邊鏡箱櫃  
 上下加T5燈 右下方含開關及插座

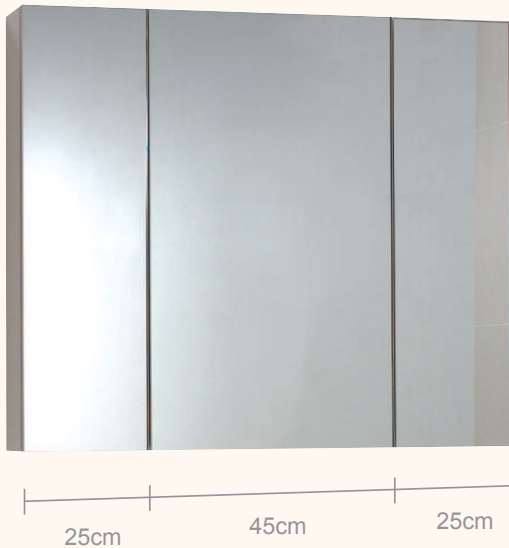

**DR-70R-12200**-亮鉻色鋁封邊鏡箱櫃  
 W70xH80xD15cm(25+45cm)

**DR-70TR-14800**-亮鉻色鋁封邊鏡箱櫃  
 上下加T5燈 右下方含開關及插座



**DR-70L-12200**-亮鉻色鋁封邊鏡箱櫃  
 W70xH80xD15cm(45+25cm)

**DR-70TL-14800**-亮鉻色鋁封邊鏡箱櫃  
 上下加T5燈 右下方含開關及插座

## 各式明鏡鏡櫃系列

※本公司全系列明鏡皆於四周特加防蝕邊處理，可增加明鏡使用壽命。  
 ※鏡片嚴禁使用含酸性或腐蝕性清潔劑擦拭。  
 ※請勿用水噴掃鏡片正面或背面。  
 ※請配合柔軟布巾以清水擦拭。



**TK-60L-10000**-鋁封邊明鏡+柚木實木平檯  
 W60xH80xD15cm

**TK-80L-11500**-鋁封邊明鏡+柚木實木平檯  
 W80xH80xD15cm



**AS-60L-9000**-鋁封邊明鏡+栓木實木平檯  
 W60xH80xD15cm

**AS-80L-10300**-鋁封邊明鏡+栓木實木平檯  
 W80xH80xD15cm

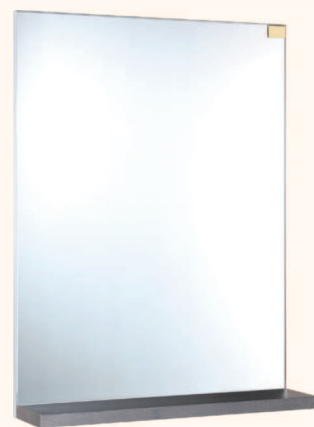

**CG-60L-9300**-鋁封邊明鏡+栓木洗灰實木平檯  
 W60xH80xD15cm

**CG-80L-10700**-鋁封邊明鏡+栓木洗灰實木平檯  
 W80xH80xD15cm



**DJ-80ML-14600**

DJ-60M+全烤漆邊櫃 W80xH80xD15cm

**DJ-100ML-15800**

DJ-80M+全烤漆邊櫃 W100xH80xD15cm



**DJ-80MR-14600**

DJ-60M+全烤漆邊櫃 W80xH80xD15cm

**DJ-100MR-15800**

DJ-80M+全烤漆邊櫃 W100xH80xD15cm

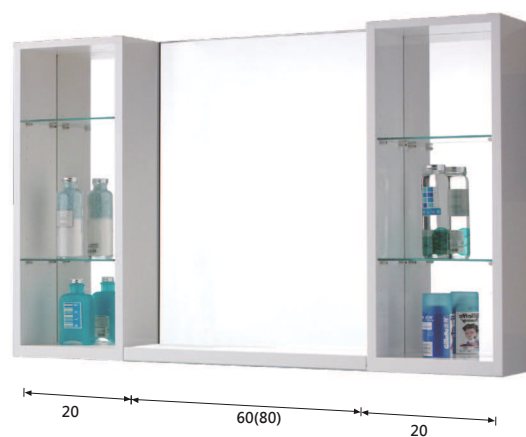

**DJ-100M-20500**

DJ-60M+左右全烤漆邊櫃 W100xH80xD15cm

**DJ-120M-21300**

DJ-80M+左右全烤漆邊櫃 W120xH80xD15cm



# 各式明鏡鏡櫃系列

在乎的 純是一種對生活的尊重與感動



**AS-80ML-16500**  
 栓木開放櫃+AS-60L W80xH80xD15cm  
**AS-100ML-18000**  
 栓木開放櫃+AS-80L W100xH80xD15cm



**AS-80MR-16500**  
 栓木開放櫃+AS-60L W80xH80xD15cm  
**AS-100MR-18000**  
 栓木開放櫃+AS-80L W100xH80xD15cm



**AS-100DM-21700**  
 左右栓木開放櫃+AS-60L W100xH80xD15cm  
**AS-120DM-24000**  
 左右栓木開放櫃+AS-80L W120xH80xD15cm



**TK-80ML-18500**  
 柚木開放櫃+TK60L W80xH80xD15cm  
**TK-100ML-20000**  
 柚木開放櫃+TK80L W100xH80xD15cm



**TK-80MR-18500**  
 柚木開放櫃+TK60L W80xH80xD15cm  
**TK-100MR-20000**  
 柚木開放櫃+TK80L W100xH80xD15cm



**CT-100M-24000**  
 左右柚木開放櫃+TK60L W100xH80xD15cm  
**CT-120M-27500**  
 左右柚木開放櫃+TK80L W120xH80xD15cm



**CG-80ML-17300**  
 栓木洗灰開放櫃+CG-60L W80xH80xD15cm  
**CG-100ML-18800**  
 栓木洗灰開放櫃+CG-80L W100xH80xD15cm



**CG-80MR-17300**  
 栓木洗灰開放櫃+CG60L W80xH80xD15cm  
**CG-100MR-18800**  
 栓木洗灰開放櫃+CG80L W100xH80xD15cm

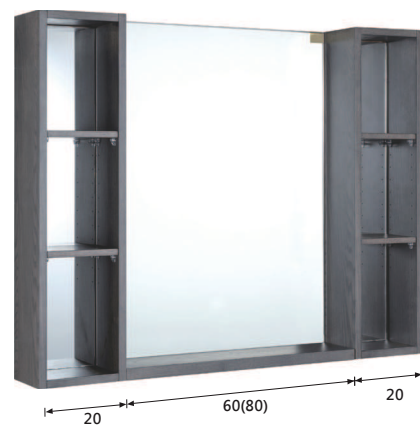

**CG-100DM-22000**  
 左右栓木洗灰開放櫃+CG-60L W100xH80xD15cm  
**CG-120DM-25000**  
 左右栓木洗灰開放櫃+CG-80L W120xH80xD15cm



## 各式明鏡鏡櫃系列

AG45或AG55鋁封邊鏡箱+五顏色側邊25cm寬開放櫃(壓克力白、加拿大冷杉、柚木色、胡桃木色、古巴硬木)美耐板

- ※本公司全系列明鏡皆於四周特加防蝕邊處理，可增加明鏡使用壽命。
- ※鏡片嚴禁使用含酸性或腐蝕性清潔劑擦拭。
- ※請勿用水噴掃鏡片正面或背面。
- ※請配合柔軟布巾以清水擦拭。



**SF-WM-70R-14000**  
壓克力白開放櫃+DR45 W70xH80xD15cm  
**SF-WM-80R-15000**  
壓克力白開放櫃+DR55 W80xH80xD15cm



**SF-WM-70L-14000**  
壓克力白開放櫃+DR45 W70xH80xD15cm  
**SF-WM-80L-15000**  
壓克力白開放櫃+DR55 W80xH80xD15cm

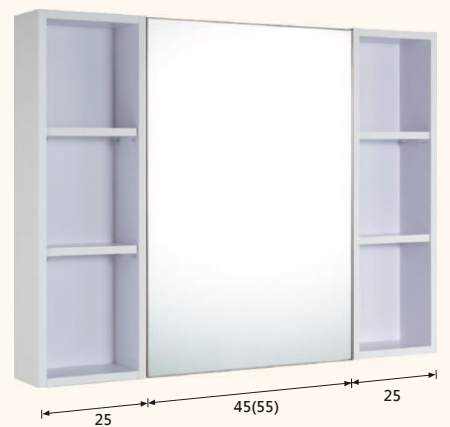

**SF-WM-95-19000**  
左右壓克力白開放櫃+DR45 W95xH80xD15cm  
**SF-WM-105-20000**  
左右壓克力白開放櫃+DR55 W105xH80xD15cm



**SF-AM-70R-14000**  
加拿大冷杉開放櫃+DR45 W70xH80xD15cm  
**SF-AM-80R-15000**  
加拿大冷杉開放櫃+DR55 W80xH80xD15cm



**SF-AM-70L-14000**  
加拿大冷杉開放櫃+DR45 W70xH80xD15cm  
**SF-AM-80L-15000**  
加拿大冷杉開放櫃+DR55 W80xH80xD15cm

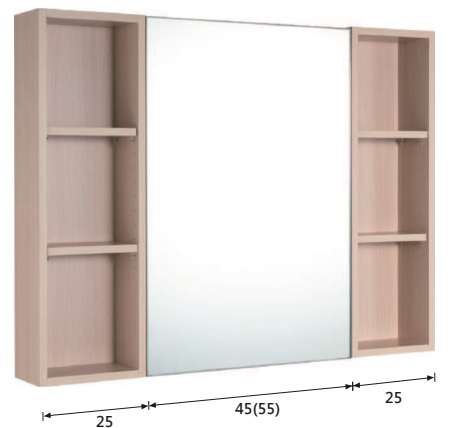

**SF-AM-95-19000**  
左右加拿大冷杉開放櫃+DR45 W95xH80xD15cm  
**SF-AM-105-20000**  
左右加拿大冷杉開放櫃+DR55 W105xH80xD15cm